

3345/FAU-13-TR

3345/MAU-13-TR

3345-C/FAU-13-TR

3345-C/MAU-13-TR

LAMPENFASSUNG F. T8/T12 LINEARE LAMPEN
ROUND LAMPHOLDERS FOR T8-T12 FLUORESCENT LINEAR LAMPS

Technische Daten

Technical data







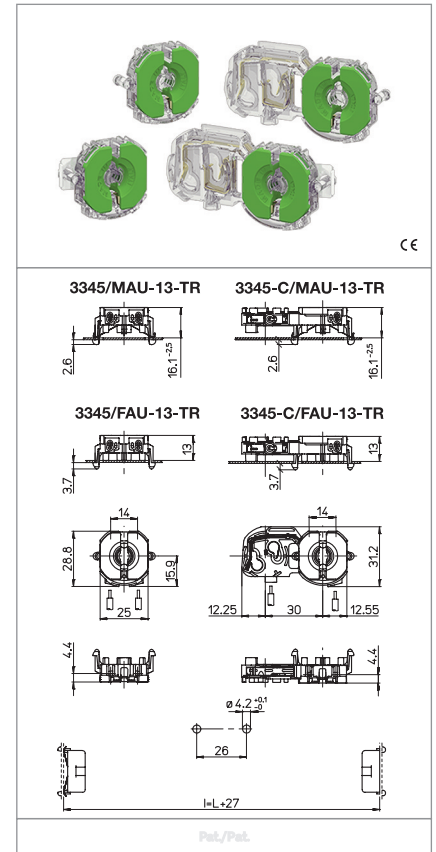

- Lampensockel - Lamp cap	G13
- Nennstrom und Nennspannung - Rated current and voltage	2A-500V
- Maximale Betriebstemperatur (IEC) - Maximum operating temperature (IEC)	T140 Tm110
- Schutzgrad - Protection index	IP20
- Überspannungskategorie - Impulse withstand category	II

Merkmale

Characteristics

- Gehäuse aus polycarbonat, transparent
- Transparent polycarbonate body
- Kupferlegierte Kontakte
- Copper alloy contacts
- Mit Top Test
- With top test



 Befestigung rückseitig <i>back mounting, fixed</i>	 Befestigung rückseitig, federnd <i>back mounting, adjustable</i>	 Blechstärke zur Befestigung <i>fixing metal plate thickness</i> 0,6-1,2	 Materialdicke <i>thickness</i> 13
 Rotor aus PBT in grün in Rastposition... <i>PBT green rotor with position of...</i>	 Steckkontakte mit 2 Löchern <i>push-wire terminals with 2 holes</i>	 Feste Leitungsabschnitte <i>rigid conductor section</i> 0,5-1	 Leitungsabsicherung <i>rigid wires stripping</i> 8-10

Prüfzeichen
Quality marks

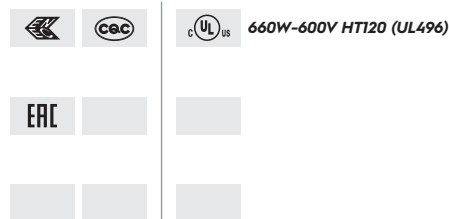

Europäische Richtlinien
European directives

gemäß "RoHS"
"RoHS" compliant
unterliegt nicht "WEEE"
Not subject to "WEEE"

Gewichte und Verpackung
Weights and packaging

Artikel/Art. Produktinweise Product references	g Nettogewicht Net weight	n° pz pro Beutel per bag	n° pz pro Box per box	n° pz pro Karton per carton
3345/FAU-13-TR	4,3	1000		
3345/MAU-13-TR	4,9	1000		
3345-C/FAU-13-TR	7	500		
3345-C/MAU-13-TR	7,6	1000		

Bemerkung

Notes